

## Features

- Single-function rainhead
- MasterClean™ sprayface features an easy-to-clean surface that withstands mineral buildup
- Optimized sprayface for maximum performance
- 2.5 gpm (9.5 lpm) maximum flow rate

## Material

- Solid-brass construction for durability and reliability

## Technology

- Katalyst™ air-induction technology infuses water with air, creating bigger drops for a more powerful spray

## Installation

- 1/2 -14 NPT connection



## Codes/Standards









ASME A112.18.1/CSA B125.1  
DOE - Energy Policy Act 1992

## KOHLER® Faucet Lifetime Limited Warranty

See website for detailed warranty information.

## Available Colors/Finishes

*Color tiles intended for reference only.*

Color	Code	Description
	CP	Polished Chrome
	SN	Vibrant™ Polished Nickel
	BN	Vibrant™ Brushed Nickel
	BV	Vibrant™ Brushed Bronze
	BL	Matte Black
	2MB	Vibrant™ Brushed Moderne Brass
	RGD	Vibrant Rose Gold
	TT	Vibrant Titanium
	VHR	

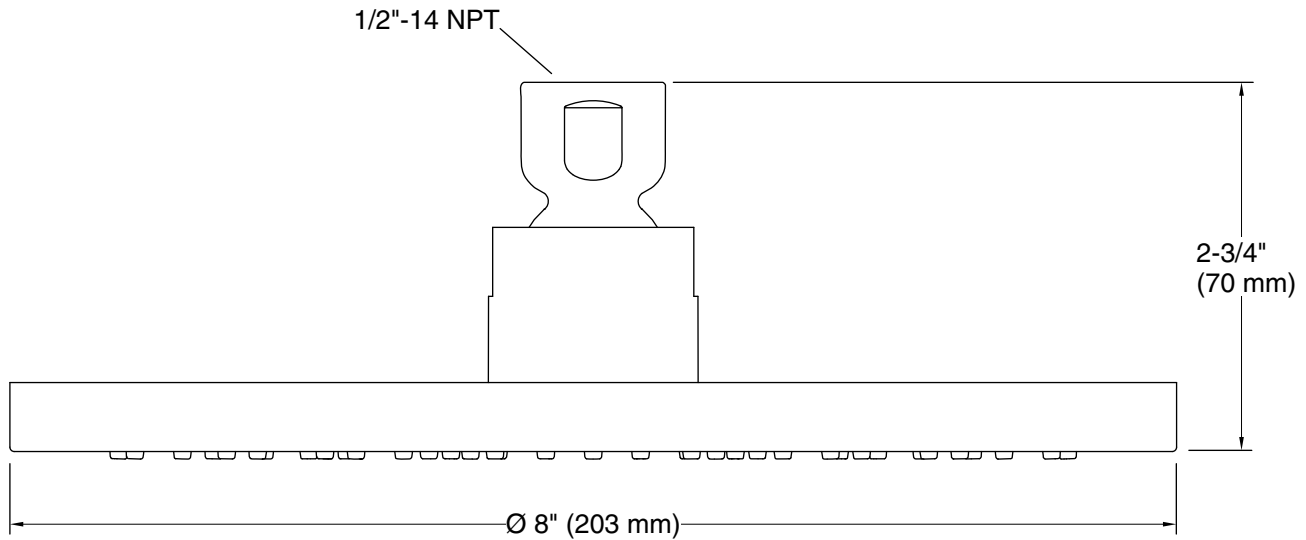

**Technical Information**

All product dimensions are nominal.

**Showerhead/Body Spray:**

Rated maximum flow: 2.5 gal/min (9.5 l/min)

**Notes**

Install this product according to the installation guide.